

# Continuous observations of high amplitude signals by the TDS receiver

David Pisa & TDS team



**DEPARTMENT  
OF SPACE PHYSICS**  
INSTITUTE OF ATMOSPHERIC PHYSICS  
CZECH ACADEMY OF SCIENCES



# RPW - Time Domain Sampler - signals

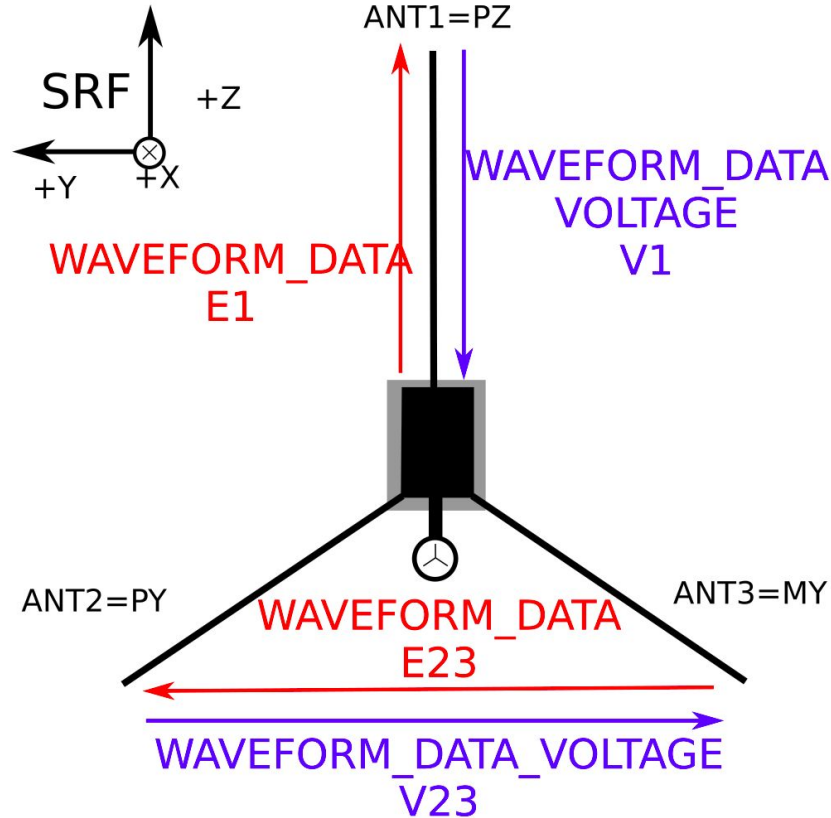

# RPW - Time Domain Sampler - inside

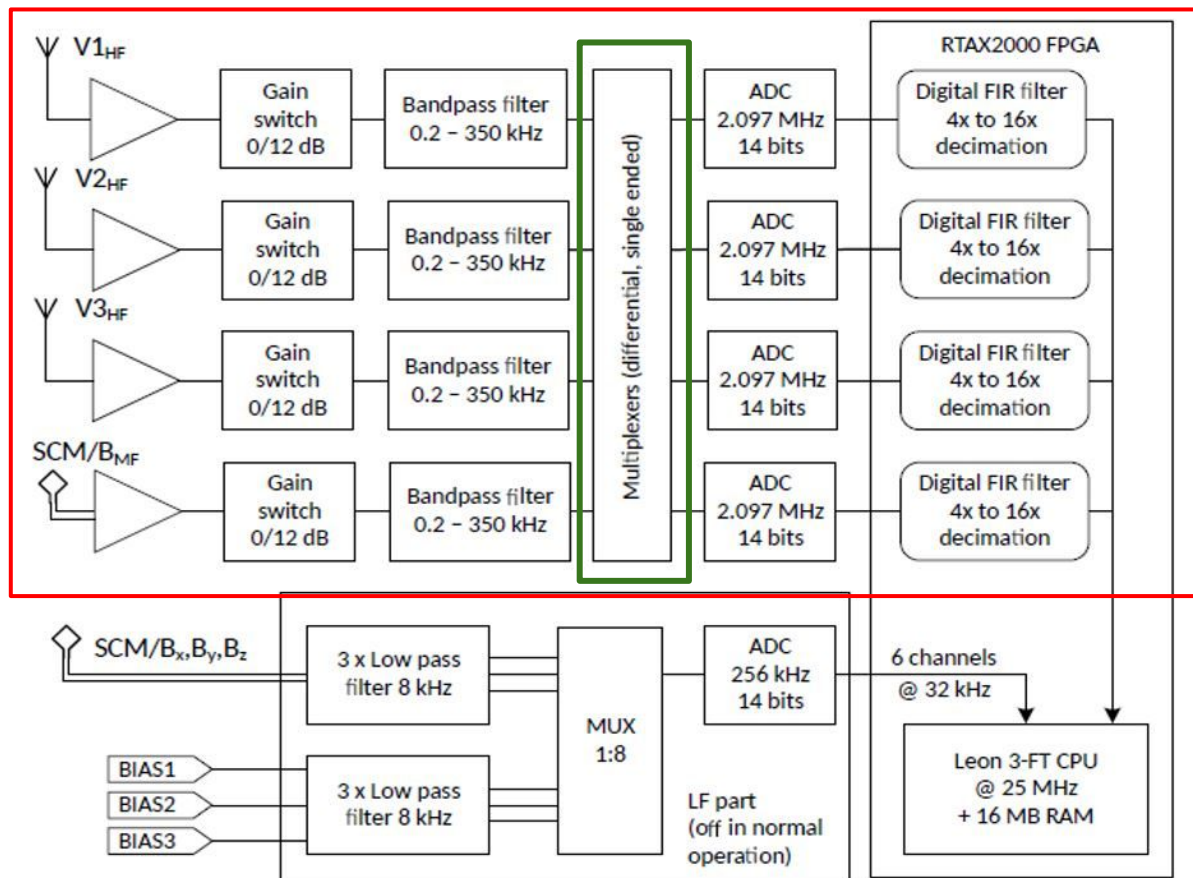

# TDS Data products

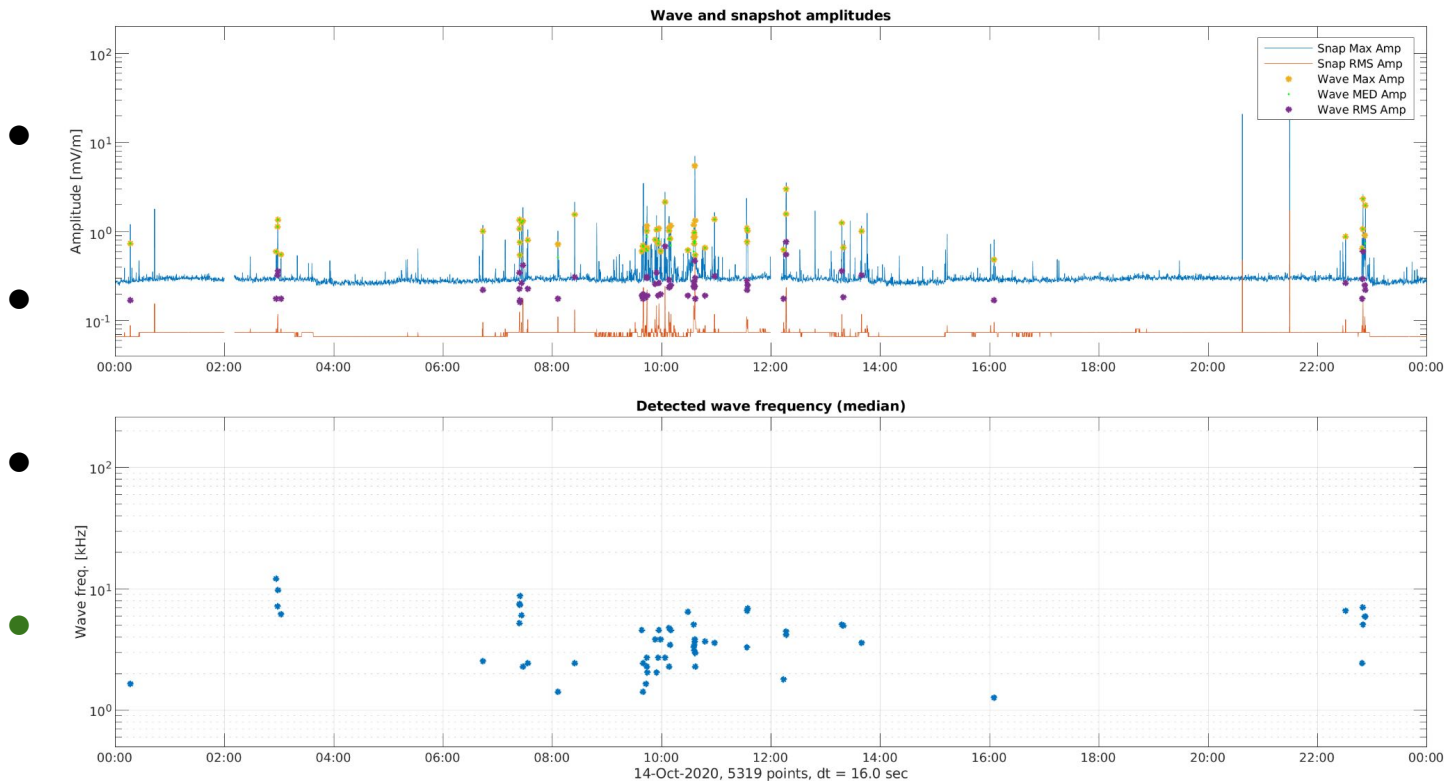

# TDS-SURV-MAMP example - Earth flyby

SoIO RPW-TDS-MAMP - 2021/10/09

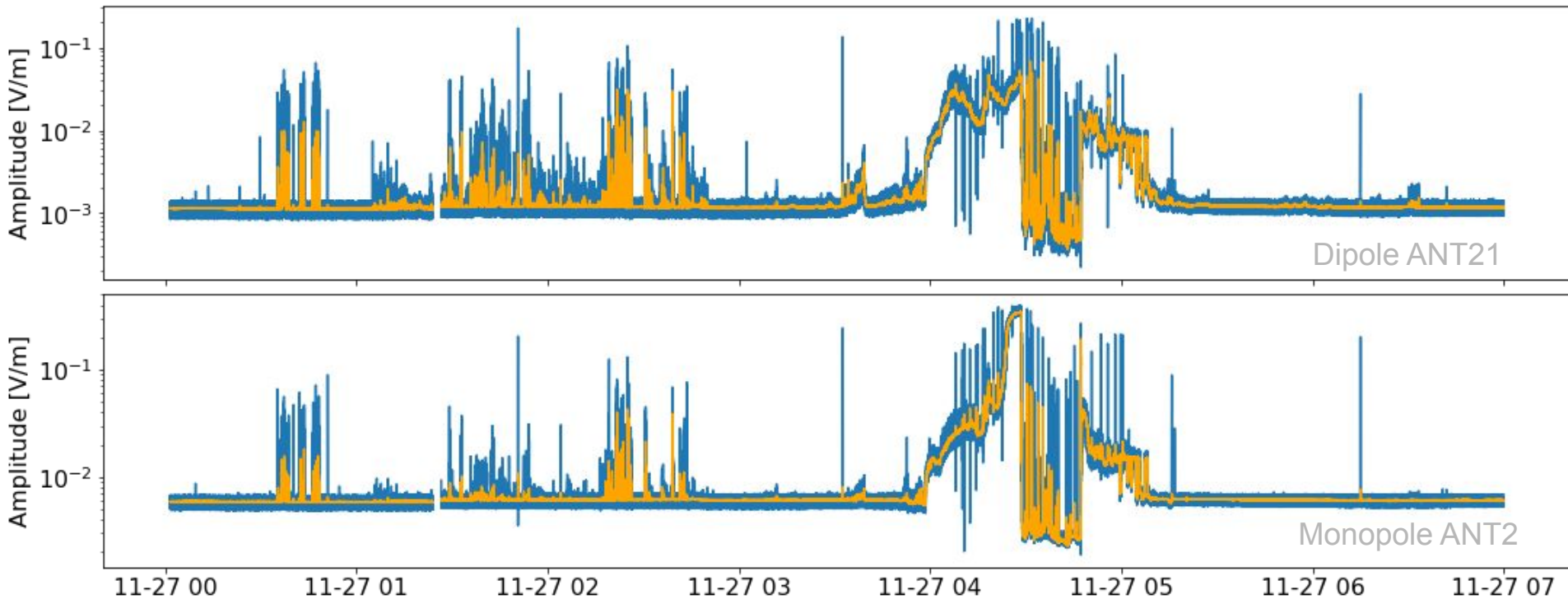

Frequency band 0.2 - 350 kHz

# TDS-SURV-MAMP 2020

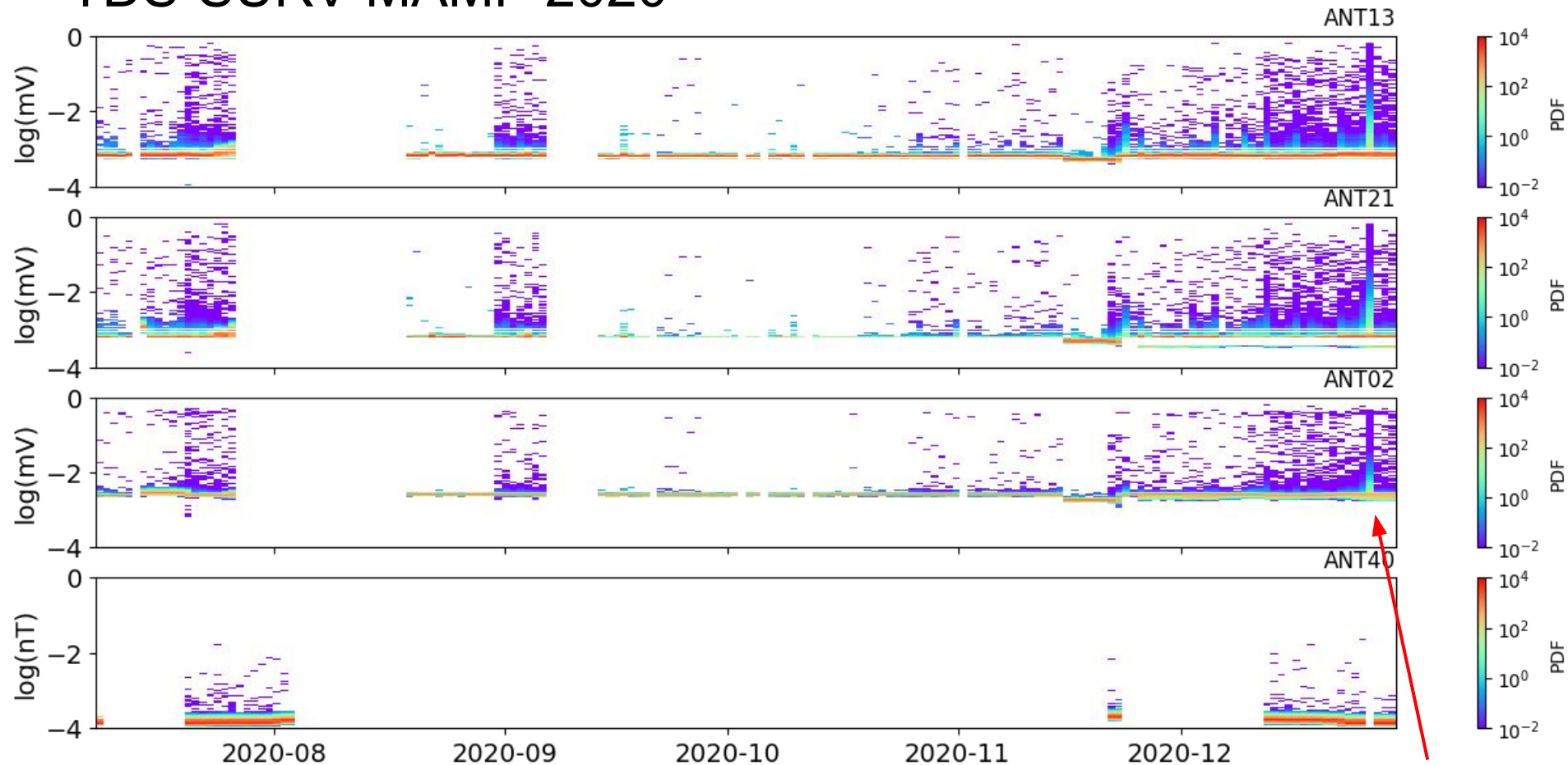

# TDS-SURV-MAMP 2021

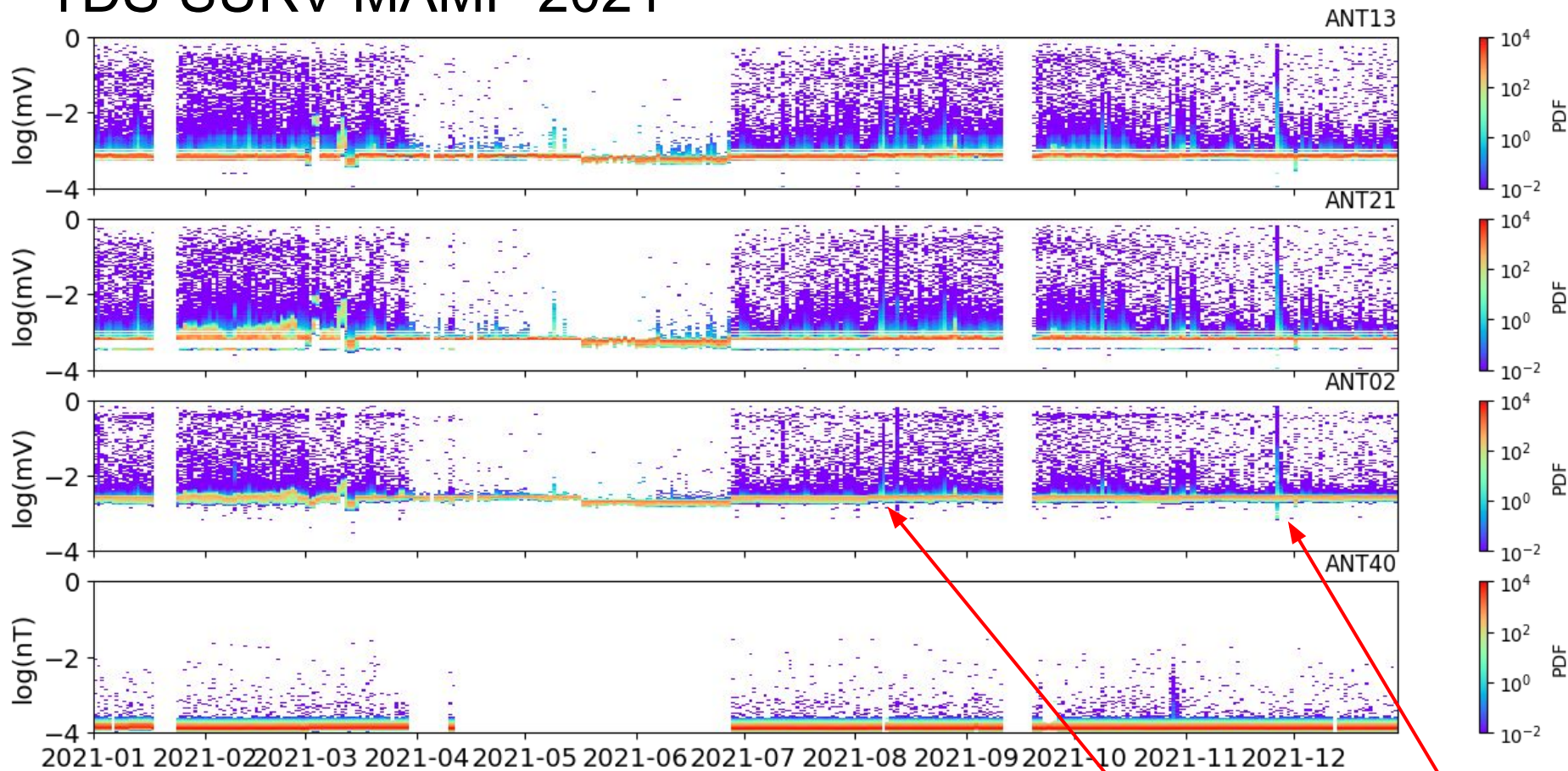

# MAMP activity Jul 2020 - Sep 2023

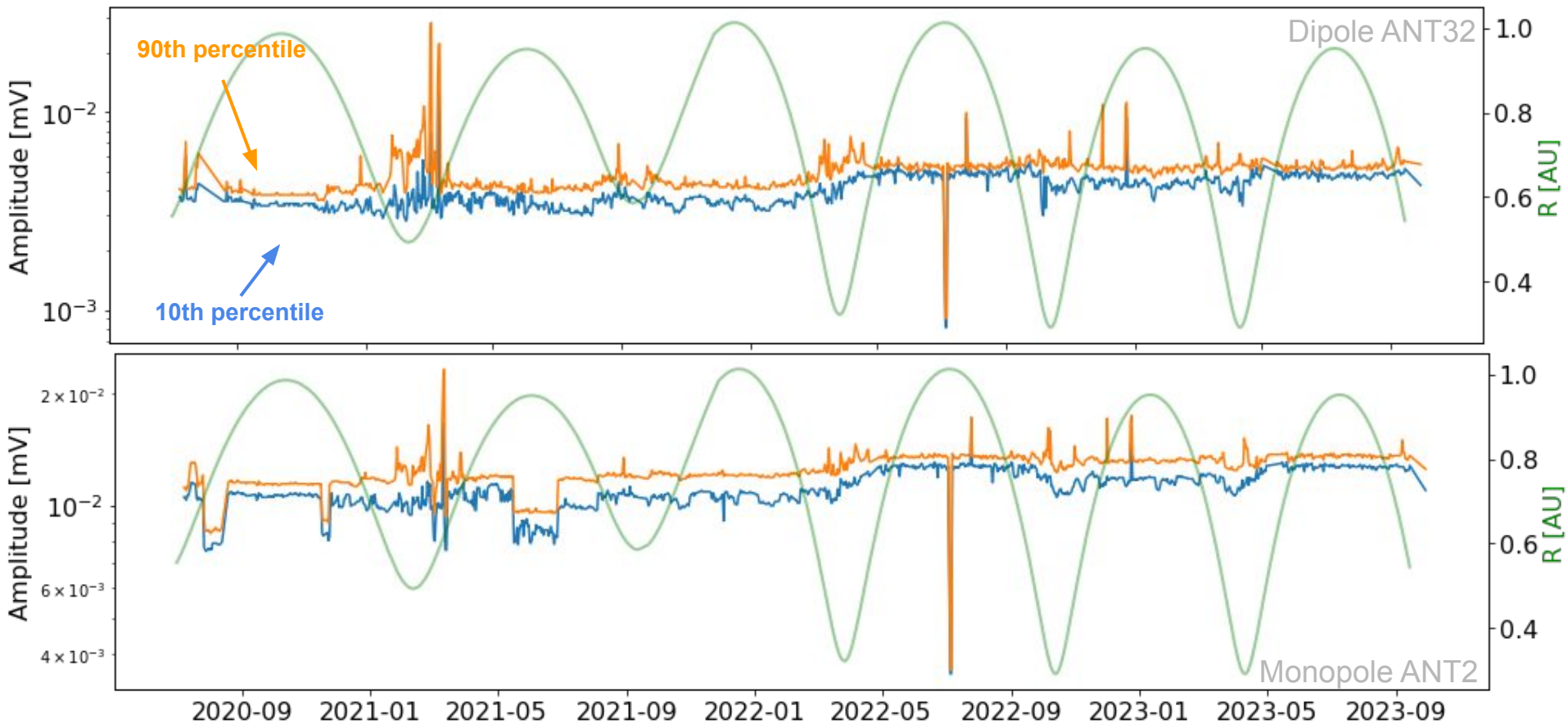



# DUST IMPACTS / MAMP vs. TSWF

Solo RPW MAMP & TSWF - 2021/01/01

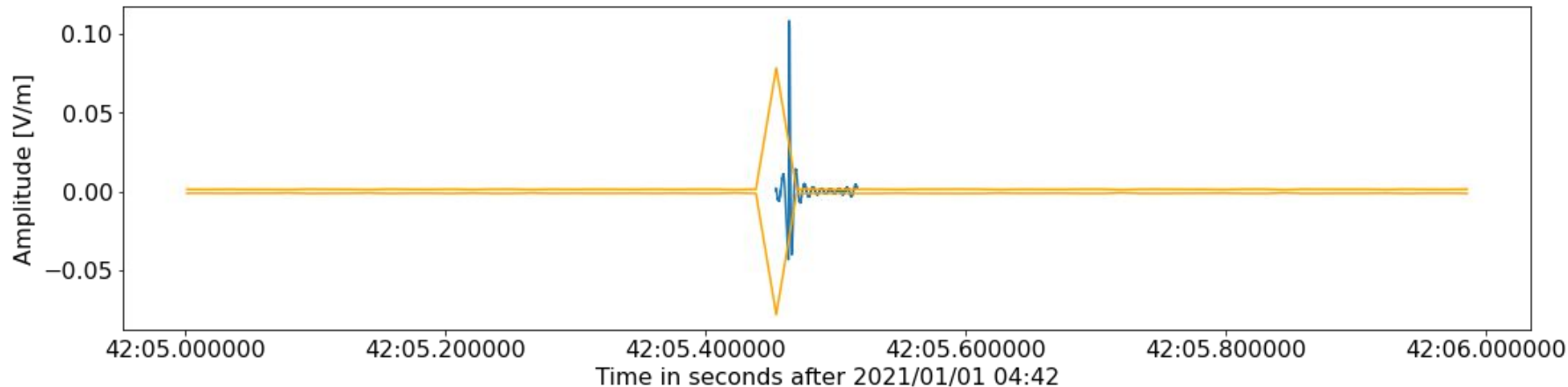

Solo RPW MAMP & TSWF - 2021/11/01

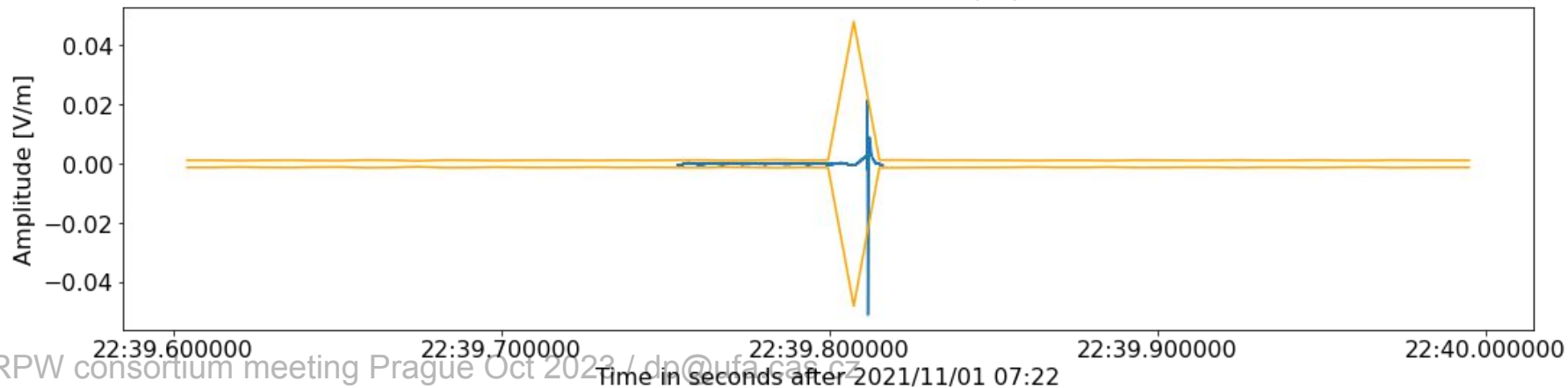

# DUST IMPACTS / MAMP vs. STAT

TDS-SURV-STAT Jul 2020 - Sep 2023

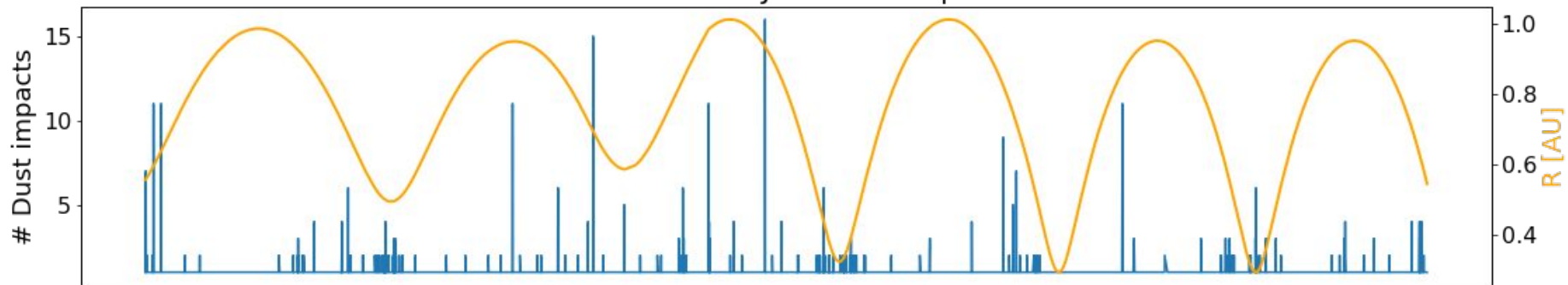

TDS-SURV-MAMP High-Peaks (>30 mV) Jul 2020 - Sep 2023

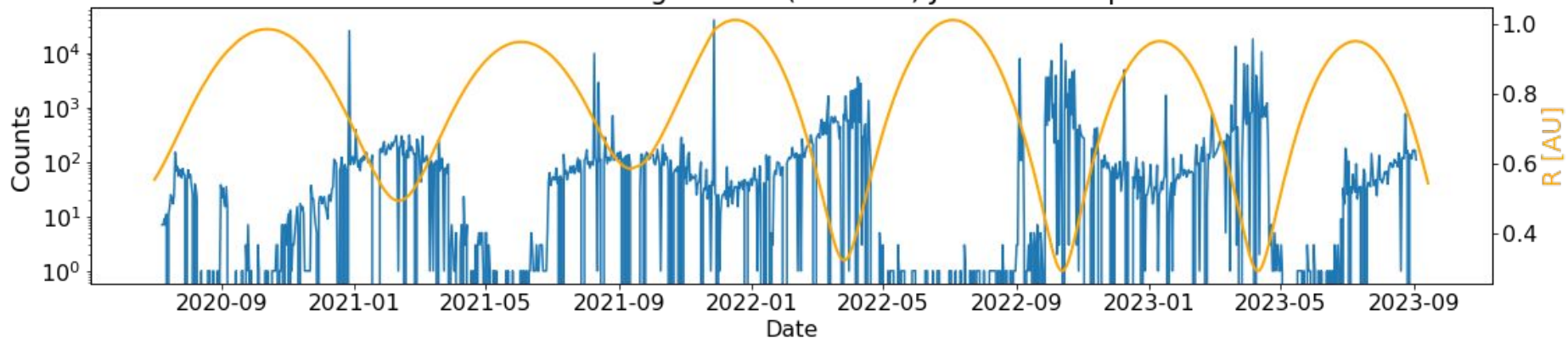

# MAMP vs. RSWF in-situ Type III

Solo RPW MAMP & RSWF - 2021/10/09

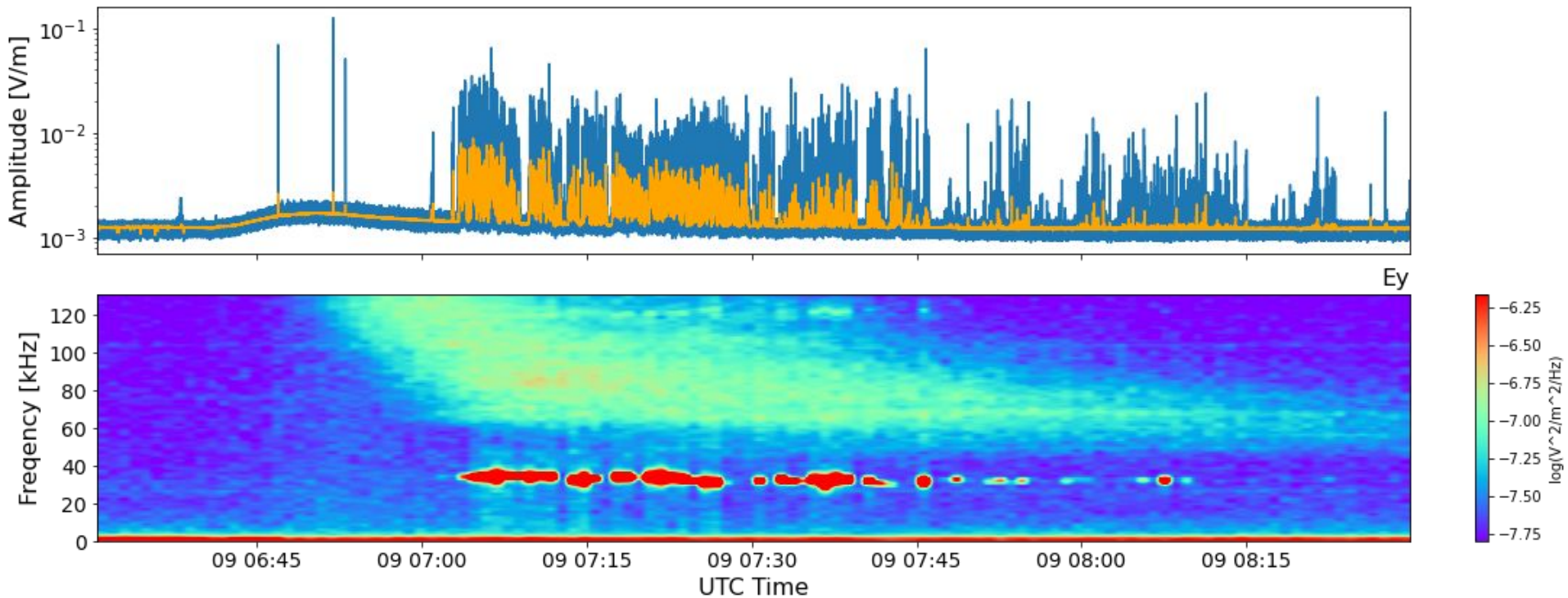

# MAMP vs RSWF in-situ Type III

SoIO RPW MAMP & RSWF - 2021/10/09

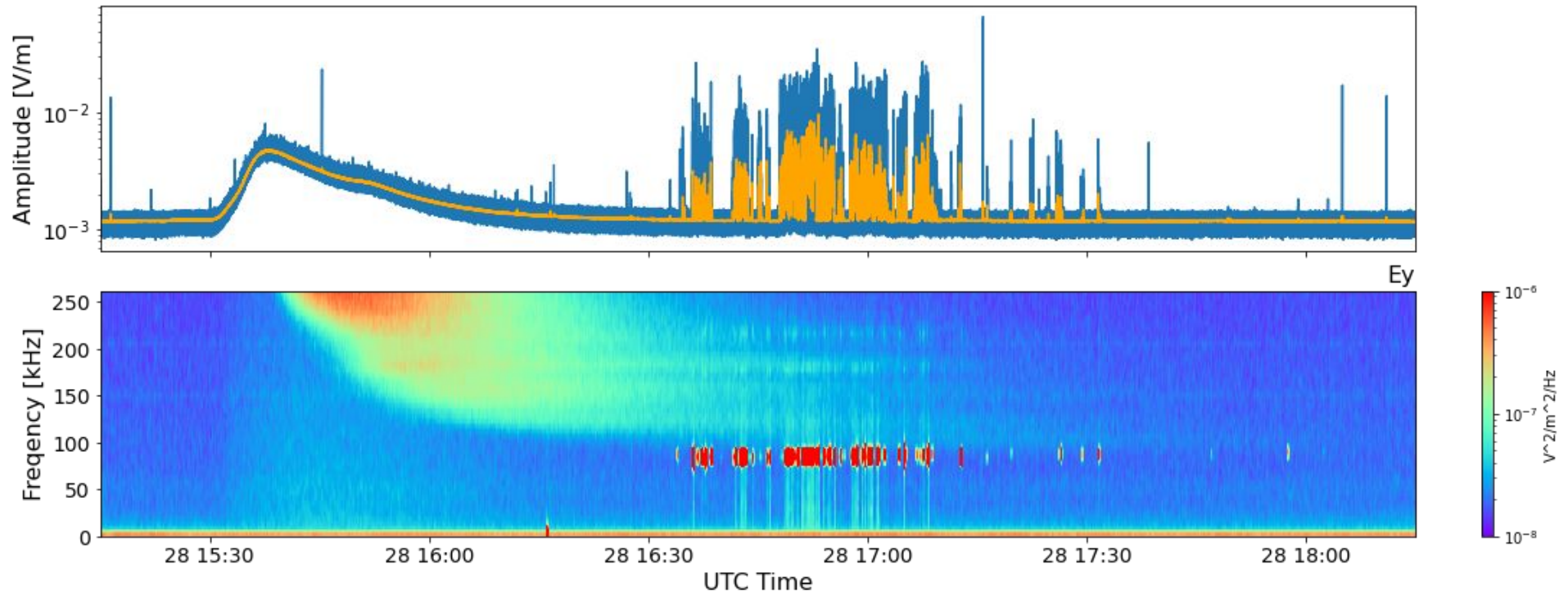

# TDS-SURV-MAMP vs Langmuir waves

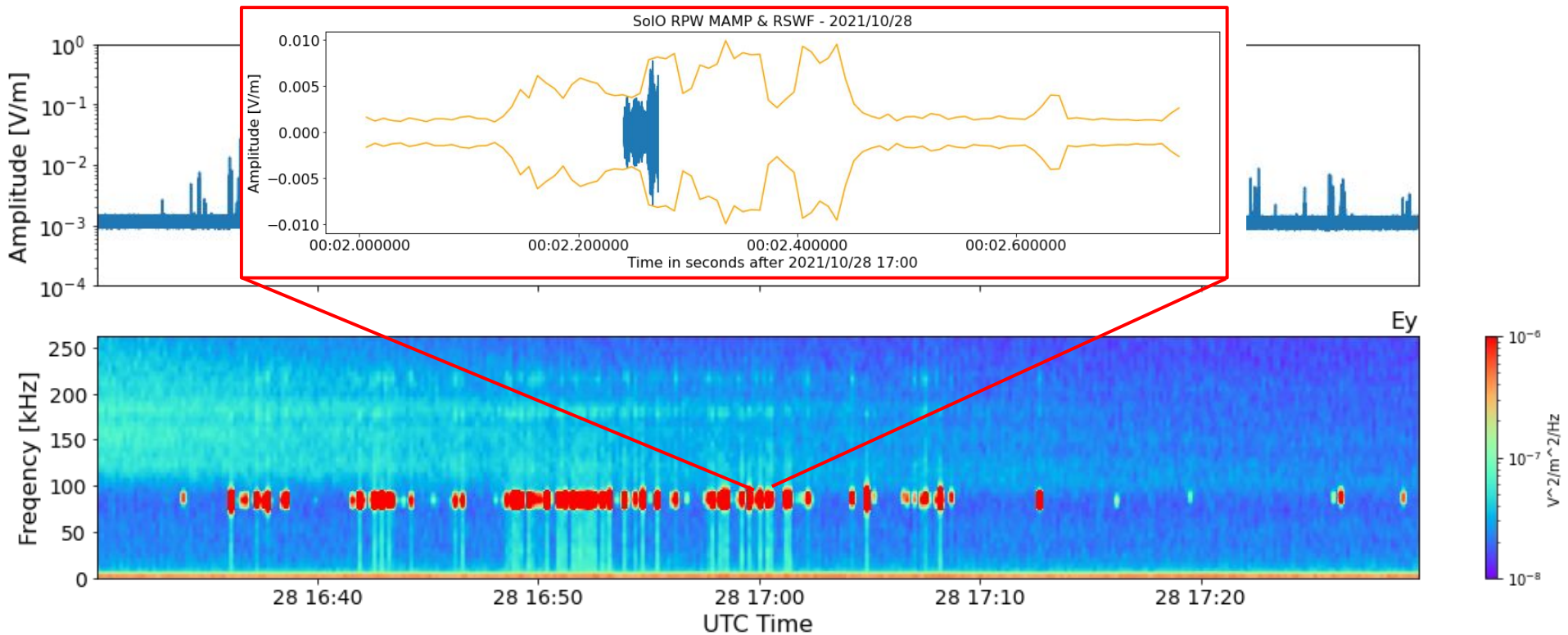

# TDS-SURV-MAMP vs IP Shocks

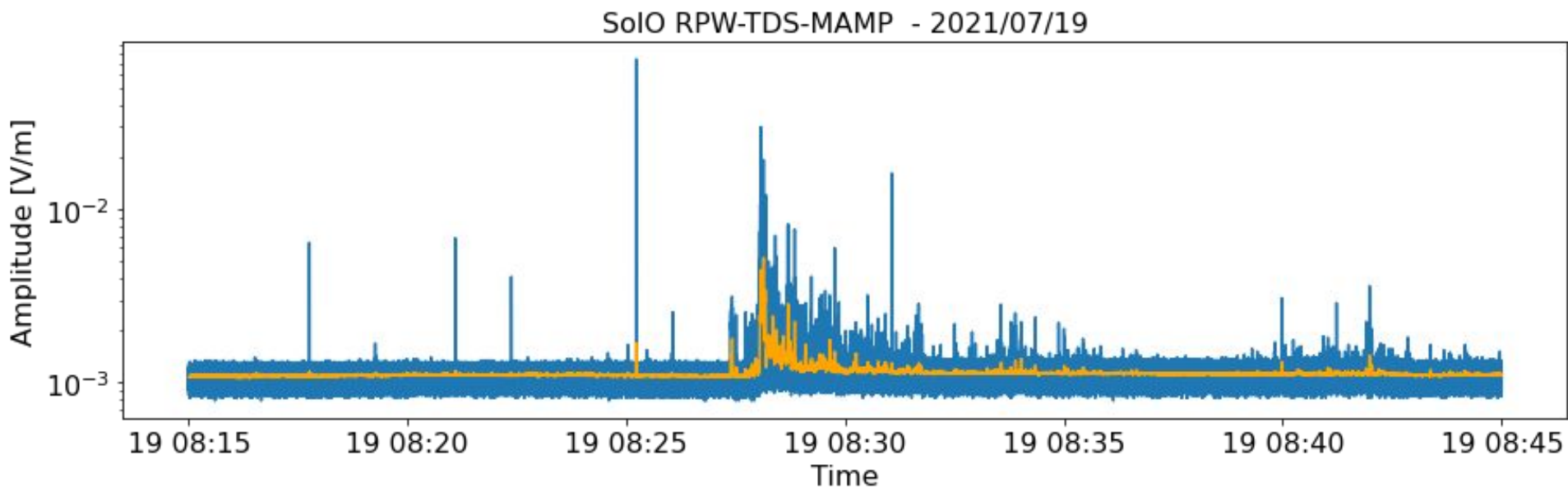

# TDS-SURV-MAMP vs IP Shocks

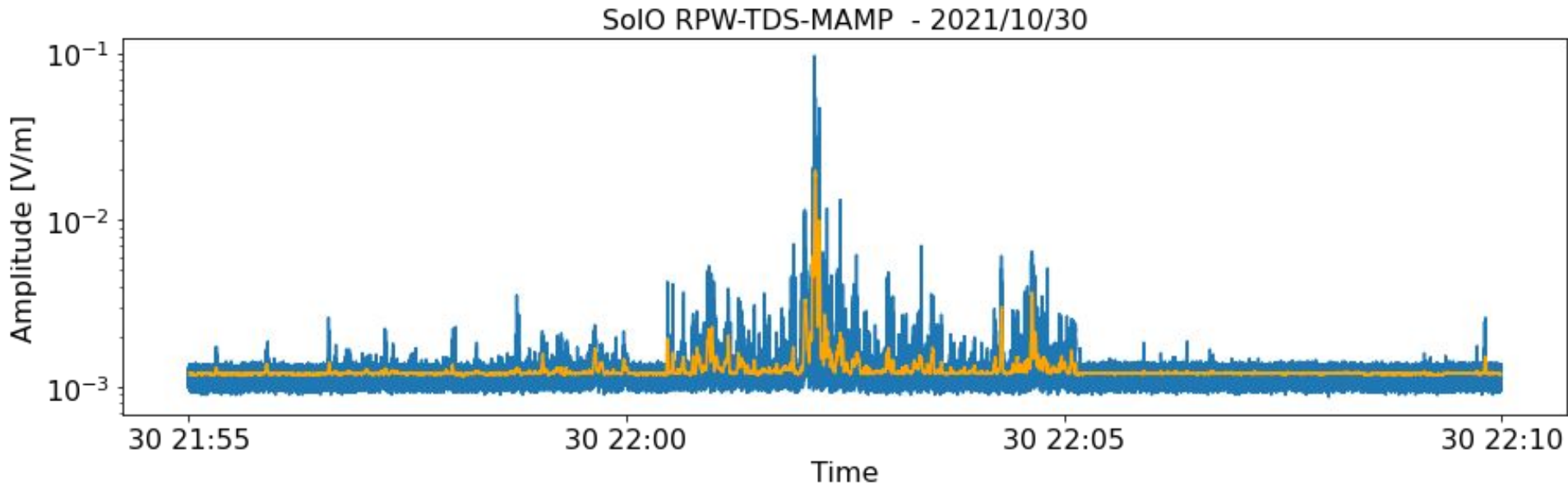

# Conclusions

- TDS measures max. absolute amplitudes with high cadence (32-128 Hz)
- MAMP can monitor
  - Wave activity - e.g. Langmuir wave envelopes, type III (<350 kHz)
  - Dust impacts
  - Region crossings - IP & planetary shocks
  - Activity at the HF SCM



DEPARTMENT  
OF SPACE PHYSICS  
INSTITUTE OF ATMOSPHERIC PHYSICS  
CZECH ACADEMY OF SCIENCES

